

# HM00-08822LFTR

**High Current**  
**Low Profile**  
**Ferrite Cube SMD Inductor**

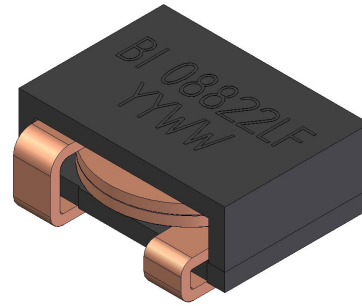

## Features

- Low DCR
- High saturation current
- Suitable for DC/DC, POL, VRM modules

## Environmental

- Operating temperature range
- RoHS compliant

-40°C to + 125°C

## Specification @ 25°C

- Inductance @ 100kHz, 100mV
- DC Resistance
- Rated Current (20% drop of inductance)
- Saturation Current (30% drop of inductance)
- Heating Current,  $\Delta T = 40^\circ\text{C}$

0.95 $\mu\text{H} \pm 15\%$   
 1.2m $\Omega$  (1.4m $\Omega$  Max)  
 27Adc  
 29Adc  
 28Adc

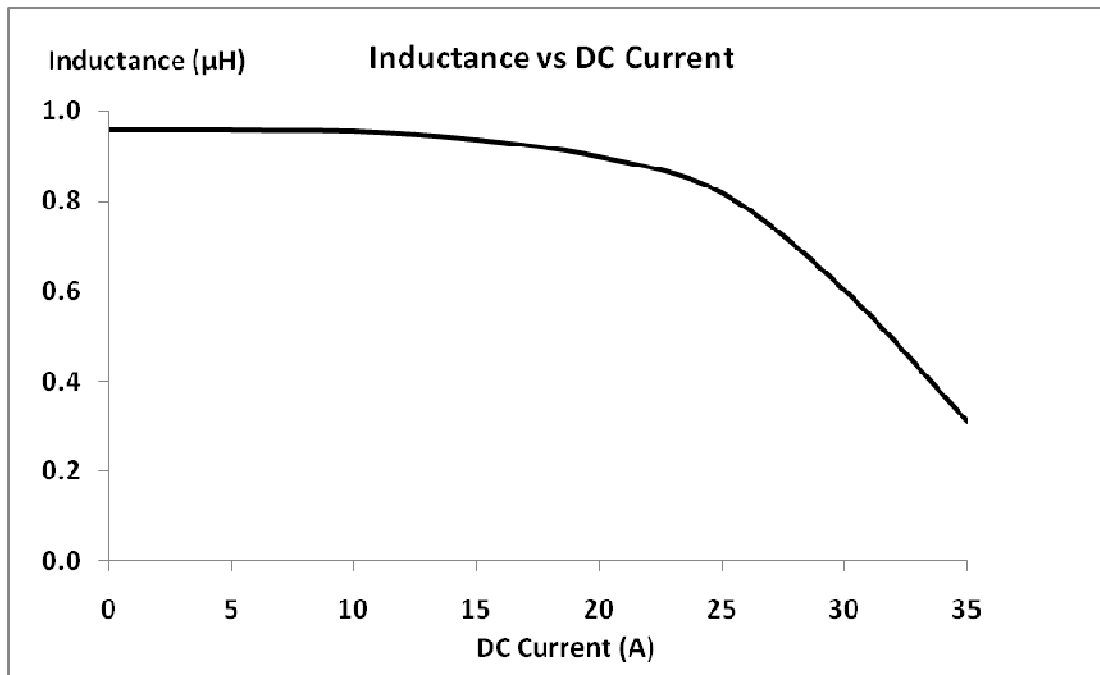

### Outline Dimensions (mm)

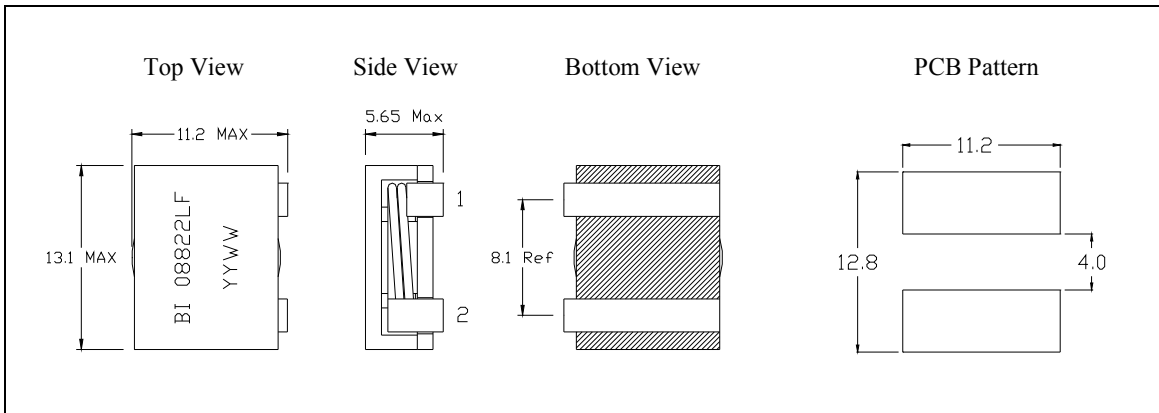

### Packaging

- One 13" reel 600pcs
- One shipping carton 6 reels or 3600pcs

